

- Ⓐ Colector drenaje 1"
1" Drainage manifold
- Ⓑ Colector entrada 3"
3" Inlet manifold
- Ⓒ Colector salida 3"
3" Outlet manifold

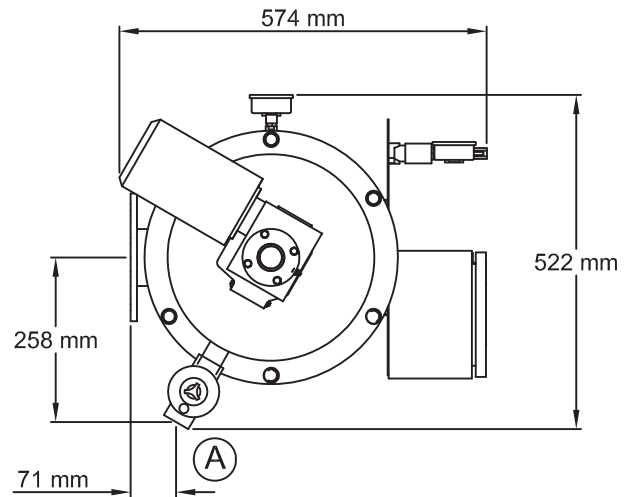

AZUD LUXON LDB 900/3

SCALE S/E A4 FORMAT	MATERIAL:	RESPONS.: M. Martínez	AZUD
	UNITS: mm.	REVISION: 00	
	FILE: Azud_luxon_LDB_900-3.dwg	12/04/2012	